

General data

Evaporation temperature	°C	-40 ÷ -20
Power supply	400V / 3Ph+N / 50Hz	
Design temps. (Tev / Tgc)	-30/35 (87 bar)	
Cooling capacity	kW	21,00
Absorbed power	kW	15,30
Refrigerant	R744	
Compressor brand	DORIN	
Compressor model	CDS2500	
Liquid receiver volume	lt	30
Liquid receiver qty	#	1
Sound pressure level @10m	[dB(A)]	46

Gas Cooler

Nbr. & Fan(s) diam	n° x ø [mm]	2 x 630
Air mass flow	m³/h	17600

Connection pipes

Liquid line	ø ["]	5/8
Suction line(s)	ø ["]	7/8

Overall dimensions

Reference drawing	layout C	
Length	mm	1650
Width	mm	910
Height	mm	1620
Weight	kg	430

Accessories included

- Galvanized steel frame, epoxy powder coated
- Semi-hermetic compressor
- Crankcase heater
- Oil pressure switch (if compressors have oil pump)
- Fins gas cooler coil on board
-
-
- Electronic fan(s)
- Liquid receiver with safety valves with changeover valve
- Electronic liquid level sensor (min. lev. alarm)
- Maximum and minimum pressure switches
- Electrical panel with terminal block
- High efficiency oil separator
- Compressor inverter driven
- Electronic oil level regulators
- Suction and liquid ball valves
- Suction filter (dryer)

Optional Accessories

-
-
-

layout A

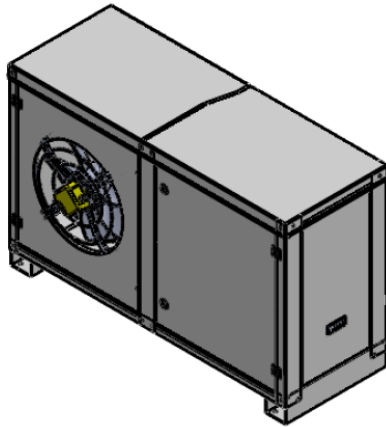

layout B

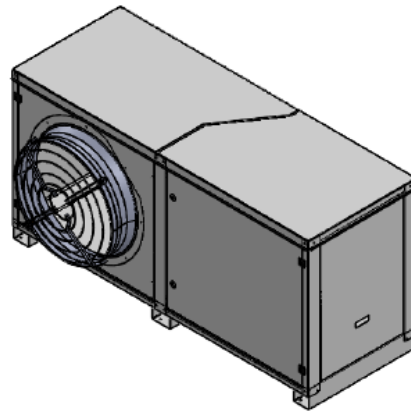

layout C

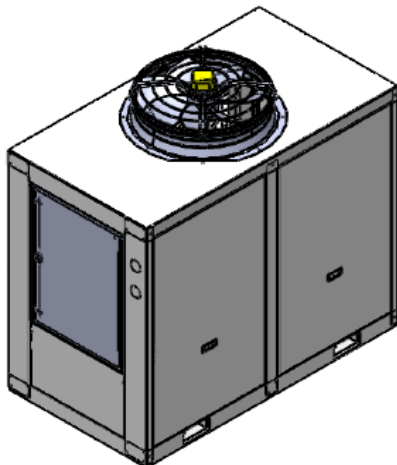

layout D

